

Hydraulic & Offshore Supplies



Tel: (+44) (0)191 549 7335
Fax: (+44) (0)191 516 0004
Website: www.hos.co.uk
E-mail: hos@hos.co.uk

Hose Fittings Multispiral











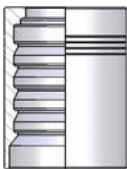





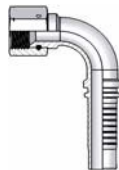



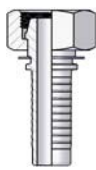



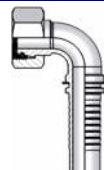

"We have set out to be the best specialist supplier of hydraulic tube, fittings, instrumentation and pipeline materials you will ever want to deal with."

Alan Wills · Managing Director



MULTISPIRAL

Pagina / Page	93		94	95	95	95
Ferrule Boccola		BSP				
	0019 R9 - 4SP - 4SH		0350M BSP MALE 60° seat AGR	0050M BSP FEMALE 60° R DKR	0150M 90° Swept Elbow R DKR-90°	0250M 45° Swept Elbow R DKR-45°
Pagina / Page	96	96	97	97		94
JIC					NPTF male	
	0850M JIC MALE 37° AGJ	0900M JIC FEMALE 37° R DKJ	0950M 90° Swept Elbow R DKJ-90°	1000M 45° Swept Elbow R DKJ-45°		0370M NPTF MALE 60° seat AGN
Pagina / Page	98	98	99	99		
FRENCH METRIC 24°						
	0430M FRENCH METRIC MALE 24°	0030M ENCH METRIC FEMALE	0130M 90° SWEPT ELBOW	0230M 45° SWEPT ELBOW		
Pagina / Page	100		100	101	101	
CES		DKOS				
	0450M METRIC MALE 24° CES		0084M FEMALE 24° OR DKOS	0184M 90° Swept Elbow OR DKOS-90°	0284M 45° Swept Elbow OR DKOS-45°	
Pagina / Page	102	102	103	103	104	104
SAE flange						
	1250M 3000 psi SOLID SFL	1050M 3000 psi SOLID 90° SFL 90°	1150M 3000 psi SOLID 45° SFL 45°	1300M 6000 psi SOLID SFS	1100M 6000 psi SOLID 90° SFS 90°	1200M 6000 psi SOLID 45° SFS 45°
Pagina / Page	105	105	105			
Super CAT						
	130SM 9000 psi SOLID SFC	110SM 9000 psi SOLID 90° SFC 90°	120SM 9000 psi SOLID 45° SFC 45°			

Dimensions and general characteristics may be changed at any time without prior notice.

Data contained herein are for information purpose only, and it does not enlarge, amend or imply any warranty other than provided by us with the product
Any use of the product not in conformance with our instructions may be dangerous.

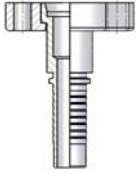
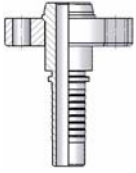
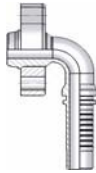

MULTISPIRAL

Pagina / Page	106	106	107
			
	F432 - F434 MALE 24° SFF	F032 - F034 FEMALE 24° SFM	F132 - F134 90° Swept Elbow SFM-90°

Gambo Multispiral: Dimensioni Disponibili

Multispiral Inserts: Available Sizes

Multispiral	1/4"	3/8"	1/2"	5/8"	3/4"	1"
-------------	------	------	------	------	------	----

Dimensions and general characteristics may be changed at any time without prior notice.

Data contained herein are for information purpose only, and it does not enlarge, amend or imply any warranty other than provided by us with the product
Any use of the product not in conformance with our instructions may be dangerous.



0019 SWAGED FERRULE (skive)

per Tubo / for Hose - R9 - 4SP - 4SH

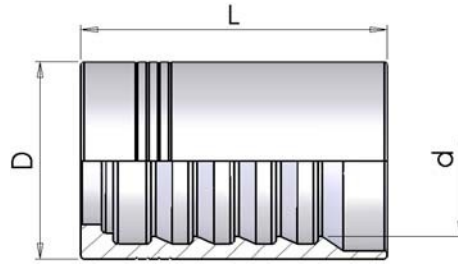

part number	hose I.D.		Dimension			skive	valid for	List Price
	in	mm	D	L	d	length		£
0019-04	1/4	6.4	21.0	40.0	15.3	30	R9 - DIN 4SP - 4SH	
0019-06	3/8	9.5	25.4	43.0	18.1	31	R9 - DIN 4SP - 4SH	
0019-08	1/2	12.7	30.0	45.0	22.2	34	R9 - DIN 4SP - 4SH	
0019-10	5/8	15.9	33.4	50.0	25.5	38	R9 - DIN 4SP - 4SH	
0019-12	3/4	19	38.0	55.0	29.4	39	R9 - DIN 4SP - 4SH	
0019-16	1	25.4	46.0	75.0	36.1	56	R9 - DIN 4SP - 4SH	



0370M NPTF MALE 60° CONE

(AGN)

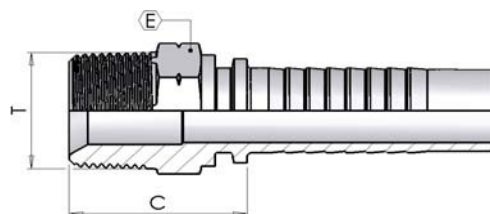

part number	hose I.D.		Dimension				List Price £
			dash size	thread T	hex E	cut-off C	
	in	mm					
0370M04-04	1/4	6.4	04	1/4-18	15	29	
0370M04-06	1/4	6.4	04	3/8-18	19	29	
0370M06-06	3/8	9.5	06	3/8-18	19	29	
0370M08-08	1/2	12.7	08	1/2-14	22	35	
0370M12-12	3/4	19	12	3/4-14	27	39	
0370M16-16	1	25.4	16	1-11.1/2	36	46	

0350M BSP MALE PARALLEL 60° CONE

(AGR)

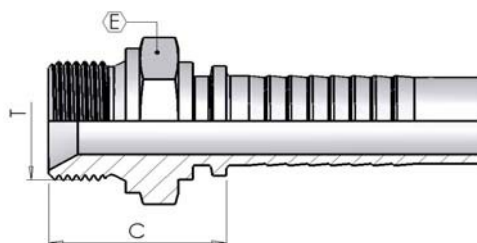

part number	hose I.D.		Dimension				List Price £
			dash size	thread T	hex E	cut-off C	
	in	mm					
0350M04-04	1/4	6.4	04	1/4-19	19	28	
0350M06-06	3/8	9.5	06	3/8-19	22	30	
0350M08-08	1/2	12.7	08	1/2-14	27	33	
0350M10-10	5/8	15.9	10	5/8-14	30	35	
0350M12-12	3/4	19	12	3/4-14	32	37	
0350M16-16	1	25.4	16	1-11	41	42	



0050M BSP FEMALE 60° CONE THRUST WIRE

(DKR)

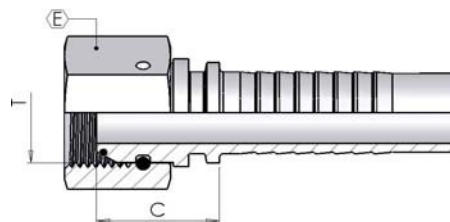

part number	hose I.D.		Dimension				List Price
			dash	thread	hex	cut-off	
	in	mm	size	T	E	C	£
0050M04-04	1/4	6.4	04	1/4-19	19	20	
0050M06-06	3/8	9.5	06	3/8-19	22	21	
0050M08-08	1/2	12.7	08	1/2-14	27	23	
0050M10-10	5/8	15.9	10	5/8-14	30	23	
0050M12-12	3/4	19	12	3/4-14	32	27	
0050M16-16	1	25.4	16	1-11	38	30	

0150M BSP 90° SWEPT ELBOW 60° CONE THRUST WIRE

(DKR 90°)

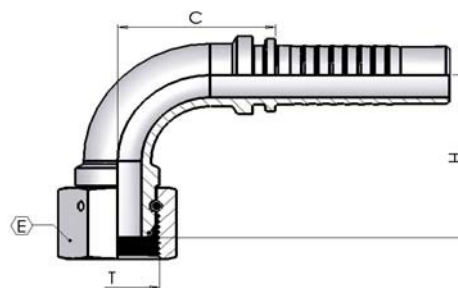

part number	hose I.D.		Dimension					List Price
			dash	thread	hex	drop	cut-off	
	in	mm	size	T	E	H	C	£
0150M04-04	1/4	6.4	04	1/4-19	19	28	26	
0150M06-06	3/8	9.5	06	3/8-19	22	34	35	
0150M08-08	1/2	12.7	08	1/2-14	27	40	40	
0150M10-10	5/8	15.9	10	5/8-14	30	46	46	
0150M12-12	3/4	19	12	3/4-14	32	56	58	
0150M16-16	1	25.4	16	1-11	38	68	72	

0250M BSP 45° SWEPT ELBOW 60° CONE THRUST WIRE

(DKR 45°)

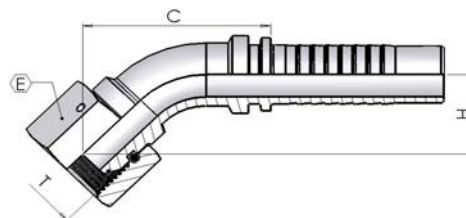

part number	hose I.D.		Dimension					List Price
			dash	thread	hex	drop	cut-off	
	in	mm	size	T	E	H	C	£
0250M04-04	1/4	6.4	04	1/4-19	19	16	43	
0250M06-06	3/8	9.5	06	3/8-19	22	19	54	
0250M08-08	1/2	12.7	08	1/2-14	27	23	67	
0250M10-10	5/8	15.9	10	5/8-14	30	24	70	
0250M12-12	3/4	19	12	3/4-14	32	29	87	
0250M16-16	1	25.4	16	1-11	38	35	108	



0850M JIC MALE 74° CONE

(AGJ)

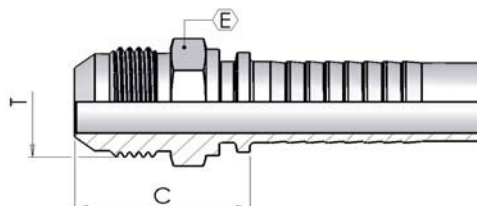

part number	hose I.D.		Dimension				List Price
			dash	thread	hex	cut-off	
	in	mm	size	TE		C	£
0850M04-04	1/4	6.4	04	7/16-20	12	28	
0850M06-06	3/8	9.5	06	9/16-18	15	28	
0850M06-08	3/8	9.5	06	3/4-16	19	32	
0850M08-08	1/2	12.7	08	3/4-16	19	32	
0850M08-10	1/2	12.7	08	7/8-14	24	36	
0850M10-10	5/8	15.9	10	7/8-14	24	36	
0850M12-12	3/4	19	12	1.1/16-12	27	40	
0850M16-16	1	25.4	16	1.5/16-12	34	45	

0900M JIC FEMALE 74° CONE THRUST WIRE

(DKJ)

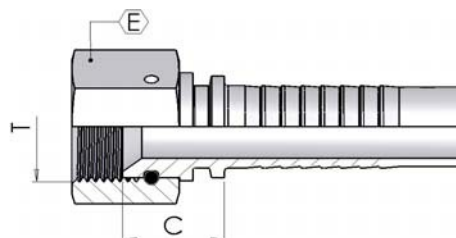

part number	hose I.D.		Dimension				List Price
			dash	thread	hex	cut-off	
	in	mm	size	T	E	C	£
0900M04-04	1/4	6.4	04	7/16-20	17	16	
0900M06-06	3/8	9.5	06	9/16-18	19	18	
0900M08-08	1/2	12.7	08	3/4-16	24	20	
0900M08-10	1/2	12.7	08	7/8-14	27	21	
0900M10-10	5/8	15.9	10	7/8-14	27	21	
0900M12-12	3/4	19	12	1.1/16-12	32	23	
0900M12-16	3/4	19	12	1.5/16-12	41	26	
0900M16-16	1	25.4	16	1.5/16-12	41	27	



0950M JIC 90° SWEEP ELBOW 74° CONE THRUST WIRE
(DKJ 90°)

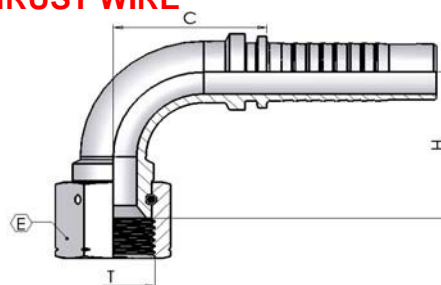

part number	hose I.D.		Dimension					List Price
			dash	thread	hex	drop	cut-off	£
	in	mm	size	T	E	H	C	
0950M04-04	1/4	6.4	04	7/16-20	17	26	26	
0950M06-06	3/8	9.5	06	9/16-18	19	33	35	
0950M08-08	1/2	12.7	08	3/4-16	24	39	40	
0950M08-10	1/2	12.7	08	7/8-14	27	41	40	
0950M10-10	5/8	15.9	10	7/8-14	27	45	46	
0950M12-12	3/4	19	12	1.1/16-12	32	54	58	
0950M16-16	1	25.4	16	1.5/16-12	41	68	72	

1000M JIC 45° SWEEP ELBOW 74° CONE THRUST WIRE
(DKJ 45°)

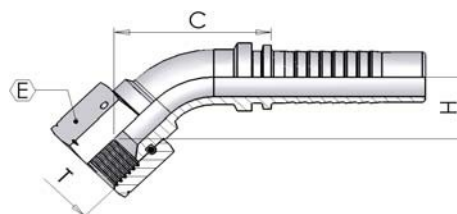

part number	hose I.D.		Dimension					List Price
			dash	thread	hex	drop	cut-off	£
	in	mm	size	T	E	H	C	
1000M04-04	1/4	6.4	04	7/16-20	17	15	42	
1000M06-06	3/8	9.5	06	9/16-18	19	18	53	
1000M08-08	1/2	12.7	08	3/4-16	24	23	66	
1000M08-10	1/2	12.7	08	7/8-14	27	23	67	
1000M10-10	5/8	15.9	10	7/8-14	27	23	69	
1000M12-12	3/4	19	12	1.1/16-12	32	28	85	
1000M16-16	1	25.4	16	1.5/16-12	41	36	109	



0430M FRENCH METRIC MALE 24°

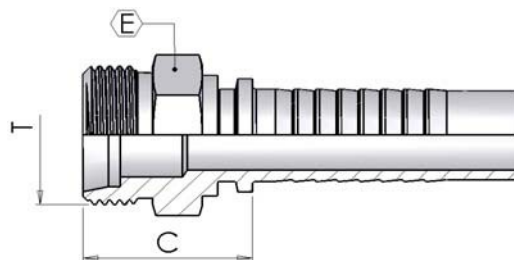

part number	hose I.D.		Dimension					List Price
			dash	thread	errm.	hex	cut-off	
	in	mm	size	T		EC£		
0430M08-24	1/2	12.7	08	M24-1.5	16.75	24	29	
0430M10-30	5/8	15.9	10	M30-1.5	21.25	32	32	
0430M12-30	3/4	19	12	M30-1.5				
0430M12-36	3/4	19	12	M36-1.5	26.75	36	35	
0430M16-45	1	25.4	16	M45-1.5	33.5	46	38	

0030M FRENCH METRIC FEMALE 24°

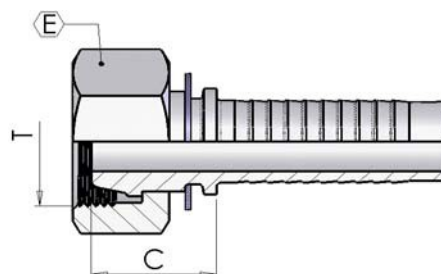

part number	hose I.D.		Dimension				List Price
			dash	thread	hex	cut-off	
	in	mm	size	T	E	C	£
0030M08-24	1/2	12.7	08	M24-1.5	30	29	
0030M10-30	5/8	15.9	10	M30-1.5	36	26	
0030M12-30	3/4	19	12	M30-1.5	36	28	
0030M12-36	3/4	19	12	M36-1.5	46	31	
0030M16-45	1	25.4	16	M45-1.5	55	32	



0130M 90° SWEPT ELBOW FRENCH METRIC 24°

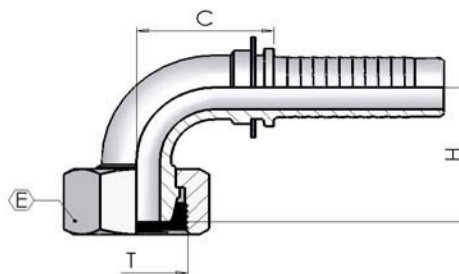

part number	hose I.D.		Dimension				List Price
			dash	thread	hex	cut-off	£
	in	mm	size	T	E	C	
0130M08-24	1/2	12.7	08	M24-1.5	30	40	
0130M10-30	5/8	15.9	10	M30-1.5	36	42	
0130M12-30	3/4	19	12	M30-1.5	36		
0130M12-36	3/4	19	12	M36-1.5	46	55	
0130M16-45	1	25.4	16	M45-1.5	55	62	

0230M 45° SWEPT ELBOW FRENCH METRIC 24°

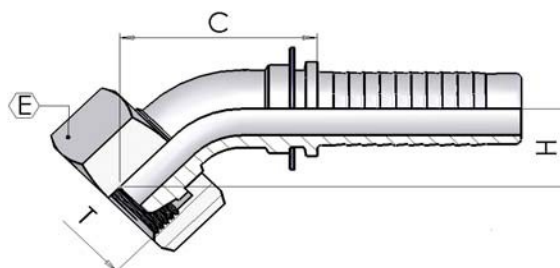

part number	hose I.D.		Dimension				List Price
			dash	thread	hex	cut-off	£
	in	mm	size	T	E	C	
0230M08-24	1/2	12.7	08	M24-1.5	30	23	
0230M10-30	5/8	15.9	10	M30-1.5	36	26	
0230M12-30	3/4	19	12	M30-1.5	36		
0230M12-36	3/4	19	12	M36-1.5	46	27	
0230M16-45	1	25.4	16	M45-1.5	55	33	



0450M METRIC MALE 24° SEAT HEAVY

(CES)

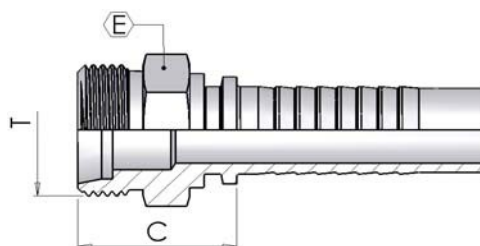

part number	hose I.D.		Dimension					List Price
			dash	thread	erm.	hex	cut-off	
	in	mm	size	T		EC£		
0450M08-24	1/2	12.7	08	M24-1.5	16	24	32	
0450M10-30	5/8	15.9	10	M30-2	20	30	34	
0450M12-30	3/4	19	12	M30-2	20	36	36	
0450M12-36	3/4	19	12	M36-2	25	36	40	
0450M16-42	1	25.4	16	M42-2	30	46	44	

0084M METRIC FEMALE 24° SEAT HEAVY

(DKOS)

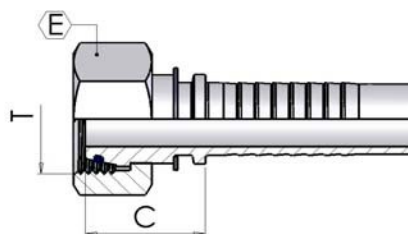

part number	hose I.D.		Dimension					List Price
			dash	thread	erm.	hex	cut-off	
	in	mm	size	T		EC£		
0084M04-16	1/4	6.4	04	M16-1.5	8	19	27	
0084M06-20	3/8	9.5	06	M20-1.5	12	24	25	
0084M08-24	1/2	12.7	08	M24-1.5	16	30	29	
0084M10-30	5/8	15.9	10	M30-2	20	36	34	
0084M12-30	3/4	19	12	M30-2	20	36	35	
0084M12-36	3/4	19	12	M36-2	25	46	41	
0084M16-36	1	25.4	16	M36-2	25	46	43	
0084M16-42	1	25.4	16	M42-2	30	50	45	



0184M 90° METRIC SWEPT ELBOW 24° SEAT HEAVY

(DKOS 90°)

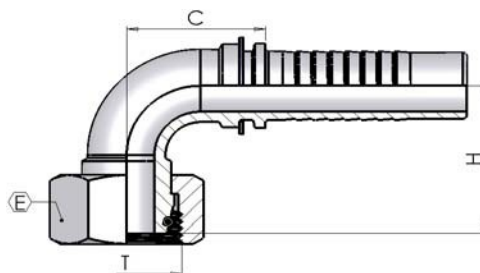

part number	hose I.D.		Dimension						List Price
			dash	thread	erm.	hex	drop	cut-off	
	in	mm	size	T		EHCE			
0184M04-16	1/4	6.4	04	M16-1.5	8	19	26	28	
0184M06-20	3/8	9.5	06	M20-1.5	12	24	33	35	
0184M08-24	1/2	12.7	08	M24-1.5	16	30	38	42	
0184M10-30	5/8	15.9	10	M30-2	20	36	51	47	
0184M12-30	3/4	19	12	M30-2	20	36	56	59	
0184M12-36	3/4	19	12	M36-2	25	46	59	58	
0184M16-42	1	25.4	16	M42-2	30	50	67	74	

0284M 45° METRIC SWEPT ELBOW 24° SEAT HEAVY

(DKOS 45°)

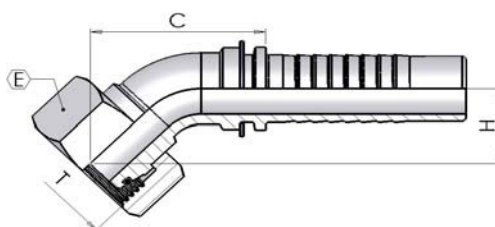

part number	hose I.D.		Dimension						List Price
			dash	thread	erm.	hex	drop	cut-off	
	in	mm	size	T		EHCE			
0284M04-16	1/4	6.4	04	M16-1.5	8	19	15	38	
0284M06-20	3/8	9.5	06	M20-1.5	12	24	19	45	
0284M08-24	1/2	12.7	08	M24-1.5	16	30	18	67	
0284M10-30	5/8	15.9	10	M30-2	20	36	29	74	
0284M12-30	3/4	19	12	M30-2	20	36	30	87	
0284M12-36	3/4	19	12	M36-2	25	46	32	91	
0284M16-42	1	25.4	16	M42-2	30	50	33	107	



1250M STRAIGHT SAE FLANGE 3000 PSI (SFL)

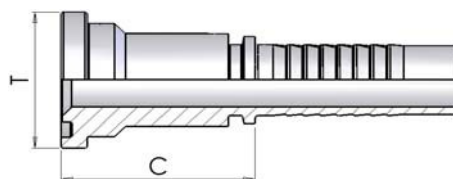

part number	hose I.D.		Dimension				List Price
			dash	flange		cut-off	
	in	mm	size	T	mm	C	£
1250M08-08	1/2	12.7	08	1/2	30.2	46	
1250M08-12	1/2	12.7	08	3/4	38.1	50	
1250M10-12	5/8	15.9	10	3/4	38.1	50	
1250M12-12	3/4	19	12	3/4	38.1	51	
1250M12-16	3/4	19	12	1	44.5	54	
1250M16-16	1	25.4	16	1	44.5	56	
1250M16-20	1	25.4	16	1.1/4	50.8	59	

1050M 90° SAE FLANGE 3000 PSI (SFL 90°)

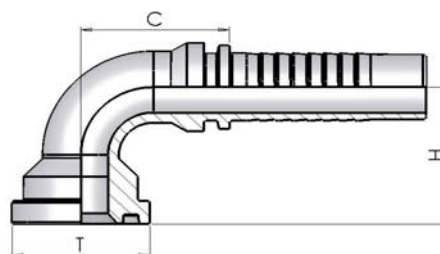

part number	hose I.D.		Dimension				List Price	
			dash	flange		drop		cut-off
	in	mm	size	T	mm	H	C	£
1050M08-08	1/2	12.7	08	1/2	30.2	39	40	
1050M08-12	1/2	12.7	08	3/4	38.1	44	40	
1050M10-12	5/8	15.9	10	3/4	38.1	47	46	
1050M12-12	3/4	19	12	3/4	38.1	53	58	
1050M12-16	3/4	19	12	1	44.5	58	58	
1050M16-16	1	25.4	16	1	44.5	65	72	
1050M16-20	1	25.4	16	1.1/4	50.8	70	72	



1150M 45° SAE FLANGE 3000 PSI

(SFL 45°)

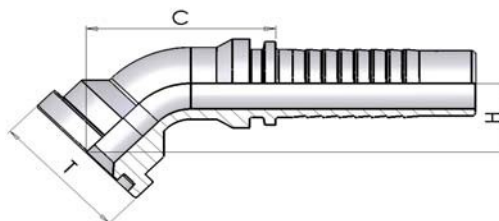

part number	hose I.D.		Dimension					List Price
			dash	flange		drop	cut-off	
	in	mm	size	T	mm	H	C	£
1150M08-08	1/2	12.7	08	1/2	30.2	22	63	
1150M08-12	1/2	12.7	08	3/4	38.1	25	69	
1150M10-12	5/8	15.9	10	3/4	38.1	24	70	
1150M12-12	3/4	19	12	3/4	38.1	27	84	
1150M12-16	3/4	19	12	1	44.5	30	88	
1150M16-16	1	25.4	16	1	44.5	33	106	
1150M16-20	1	25.4	16	1.1/4	50.8	37	110	

1300M STRAIGHT SAE FLANGE 6000 PSI

(SFS)

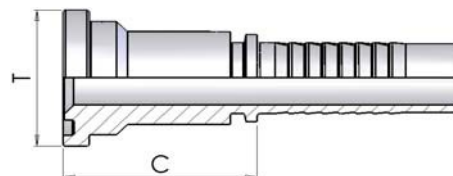

part number	hose I.D.		Dimension				List Price
			dash	flange		cut-off	
	in	mm	size	T	mm	C	£
1300M08-08	1/2	12.7	08	1/2	31.7	47	
1300M08-12	1/2	12.7	08	3/4	41.3	54	
1300M10-12	5/8	15.9	10	3/4	41.3	54	
1300M12-12	3/4	19	12	3/4	41.3	55	
1300M12-16	3/4	19	12	1	47.6	61	
1300M12-20	3/4	19	12	1.1/4	54	69	
1300M16-12	1	25.4	16	3/4	41.3	57	
1300M16-16	1	25.4	16	1	47.6	63	
1300M16-20	1	25.4	16	1.1/4	54	70	



1100M 90° SAE FLANGE 6000 PSI

(SFS 90°)

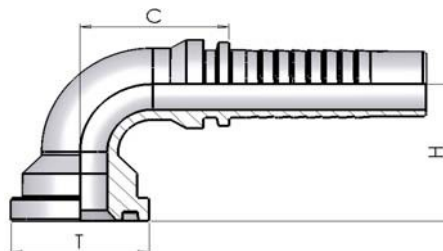

part number	hose I.D.		Dimension					List Price
			dash size	flange		drop	cut-off	£
	in	mm		T	mm	H	C	
1100M08-08	1/2	12.7	08	1/2	31.7	39	40	
1100M08-12	1/2	12.7	08	3/4	41.3	48	40	
1100M10-12	5/8	15.9	10	3/4	41.3	51	46	
1100M12-12	3/4	19	12	3/4	41.3	57	58	
1100M12-16	3/4	19	12	1	47.6	63	56	
1100M16-12	1	25.4	16	3/4	41.3	64	72	
1100M16-16	1	25.4	16	1	47.6	70	72	
1100M16-20	1	25.4	16	1.1/4	54	77	72	

1200M 45° SAE FLANGE 6000 PSI

(SFS 45°)

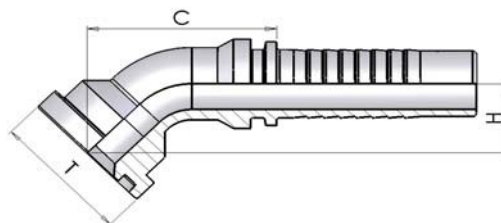

part number	hose I.D.		Dimension					List Price
			dash size	flange		drop	cut-off	£
	in	mm		T	mm	H	C	
1200M08-08	1/2	12.7	08	1/2	31.7	22	66	
1200M08-12	1/2	12.7	08	3/4	41.3	28	70	
1200M10-12	5/8	15.9	10	3/4	41.3	27	73	
1200M12-12	3/4	19	12	3/4	41.3	30	87	
1200M12-16	3/4	19	12	1	47.6	34	94	
1200M16-12	1	25.4	16	3/4	41.3	35	103	
1200M16-16	1	25.4	16	1	47.6	37	109	
1200M16-20	1	25.4	16	1.1/4	54	41	115	



130SM STRAIGHT 'CAT' FLANGE

(SFC)

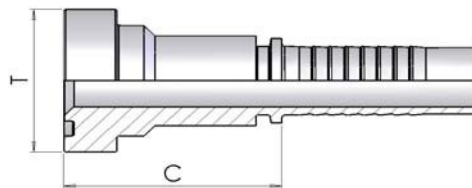

part number	hose I.D.		Dimension				List Price
			dash	flange		cut-off	
	in	mm	size	T	mm	C	£
130SM12-12	3/4	19	12	3/4	41	59	
130SM12-16	3/4	19	12	1	48	66	
130SM16-16	1	25.4	16	1	48	67	
130SM16-20	1	25.4	16	1.1/4	54	75	

110SM 90° 'CAT' FLANGE

(SFC 90°)

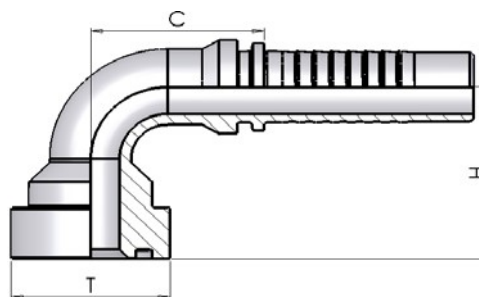

part number	hose I.D.		Dimension				List Price	
			dash	flange		drop		cut-off
	in	mm	size	T	mm	H	C	£
110SM12-12	3/4	19	12	3/4	41	60	58	
110SM12-16	3/4	19	12	1	48	67	58	
110SM16-16	1	25.4	16	1	48	74	80	
110SM16-20	1	25.4	16	1.1/4	54	80	79	

120SM 45° 'CAT' FLANGE

(SFC 45°)

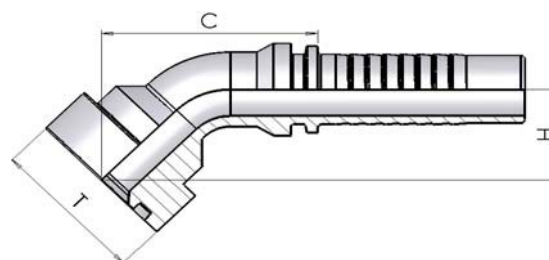

part number	hose I.D.		Dimension				List Price	
			dash	flange		drop		cut-off
	in	mm	size	T	mm	H	C	£
120SM12-12	3/4	19	12	3/4	41	32	90	
120SM12-16	3/4	19	12	1	48	33	97	
120SM16-16	1	25.4	16	1	48	40	121	
120SM16-20	1	25.4	16	1.1/4	54	44	124	



F432M

POCLAIN MALE FLANGE

F434M

(SFF)

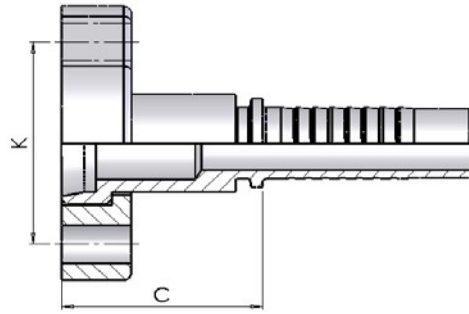

part number	hose I.D.		Dimension						List Price
			dash	flange			dim	cut-off	
	in	mm	size	T			K	C	£
F432M08-08	1/2	12.7	08	1/2			44	41	
F432M10-10	5/8	15.9	10	5/8			44	41	
F432M12-12	3/4	19	12	3/4			56	52	
F432M16-16	1	25.4	16	1			64	64	
F432M20-20	1.1/4	31.8	20	1.1/4			74	70	
F434M08-08	1/2	12.7	08	1/2			40	41	
F434M10-10	5/8	15.9	10	5/8			40	41	
F434M12-12	3/4	19	12	3/4			51	52	
F434M16-16	1	25.4	16	1			57	64	
F434M20-20	1.1/4	31.8	20	1.1/4			67	70	

F032M

POCLAIN FEMALE FLANGE

F034M

(SFM)

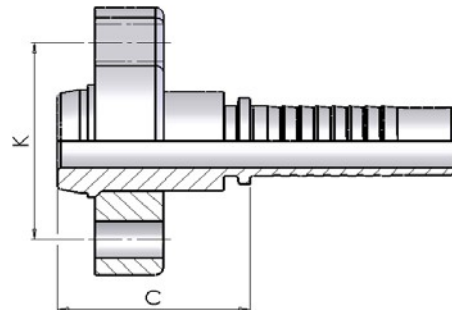

part number	hose I.D.		Dimension						List Price
			dash	flange			dim	cut-off	
	in	mm	size	T			K	C	£
F032M08-08	1/2	12.7	08	1/2			44	45	
F032M10-10	5/8	15.9	10	5/8			44	44	
F032M12-12	3/4	19	12	3/4			56	51	
F032M16-16	1	25.4	16	1			64	62	
F032M20-20	1.1/4	31.8	20	1.1/4			74	82	
F034M08-08	1/2	12.7	08	1/2			40	45	
F034M10-10	5/8	15.9	10	5/8			40	44	
F034M12-12	3/4	19	12	3/4			51	51	
F034M16-16	1	25.4	16	1			57	62	
F034M20-20	1.1/4	31.8	20	1.1/4			67	82	



F132M

90° POCLAIN FEMALE FLANGE

F134M

(SFM 90°)

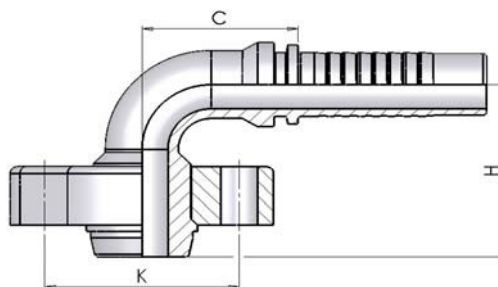

part number	hose I.D.		Dimension							List Price
			dash	flange			dim	drop	cut-off	
	in	mm	size	T			K	H	C	£
F132M08-08	1/2	12.7	08	1/2			44	50	40	
F132M10-10	5/8	15.9	10	5/8			44	52	48	
F132M12-12	3/4	19	12	3/4			56	62	63	
F132M16-16	1	25.4	16	1			64	81	80	
F132M20-20	1.1/4	31.8	20	1.1/4			74	100	85	
F134M08-08	1/2	12.7	08	1/2			40	50	40	
F134M10-10	5/8	15.9	10	5/8			40	52	48	
F134M12-12	3/4	19	12	3/4			51	62	63	
F134M16-16	1	25.4	16	1			57	81	80	
F134M20-20	1.1/4	31.8	20	1.1/4			67	100	85	